

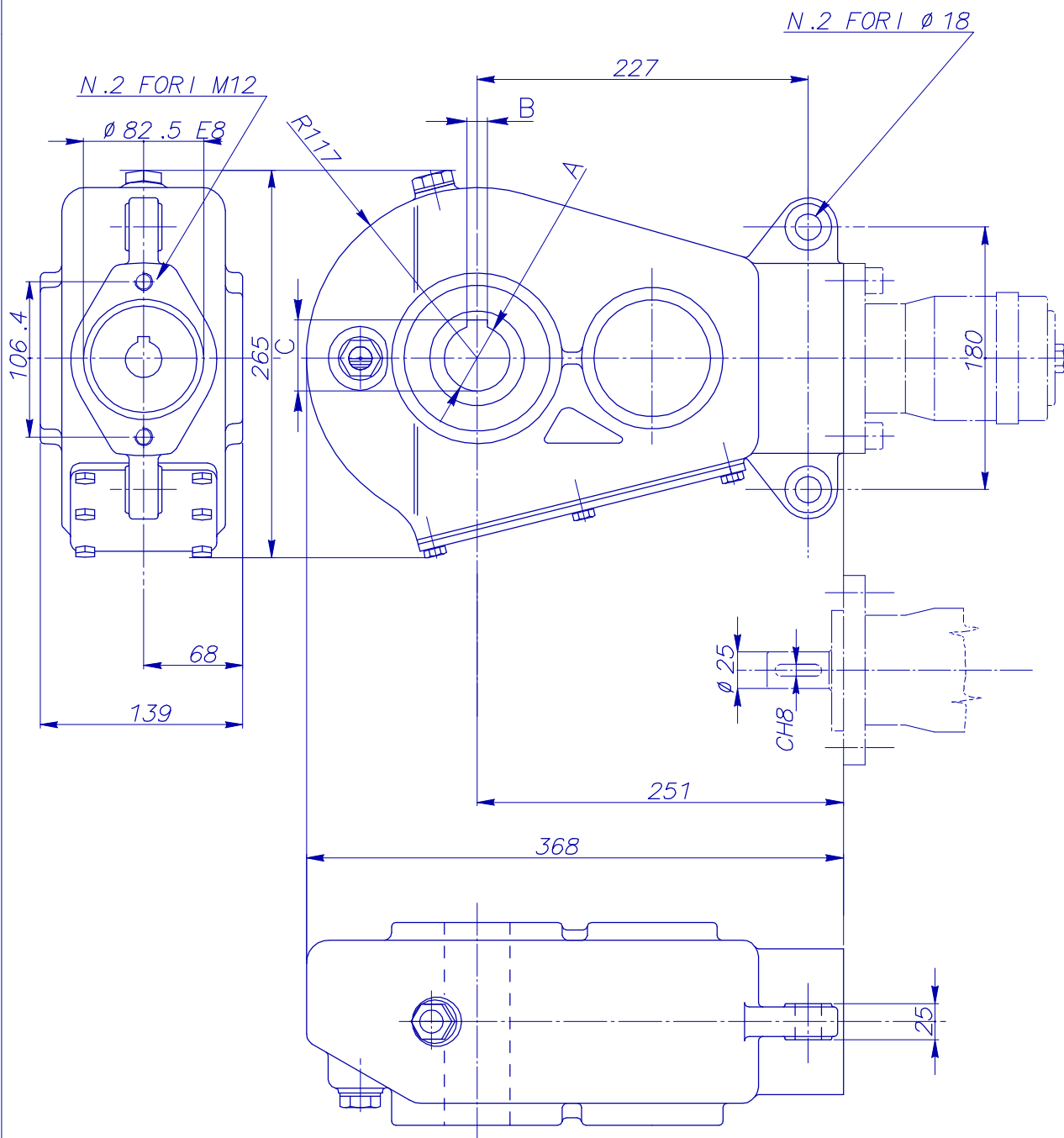

Riduttore RT 200



Marca	A E8	B E8	C	Peso kg.	Rapporto	Mt.in uscita N m	Olio Tipo	Quantita Kg	Temperatura d'impiego:
9356	35	10	38,8						
9357	40	12	43,8	27	16,4:1	2000	SAE 90 EP	2,3	-20° C +80° C
9358	45	12	48,8						